

Single Phase Power Calibrator and Tester of Power Engineering Devices

CP11 Power Calibrator and Tester

- Voltage source up to 560V
- Current source up to 120A with a single pair of current sockets
- Accuracy class 0.02% or 0.05% to calibrate digital instruments
- Single product in a single case without auxiliary amplifiers
- High burden of outputs to drive older analogue instruments
- Large color Touchscreen and Calpro 300 PCsoft
- Manual mode and automatic test procedures

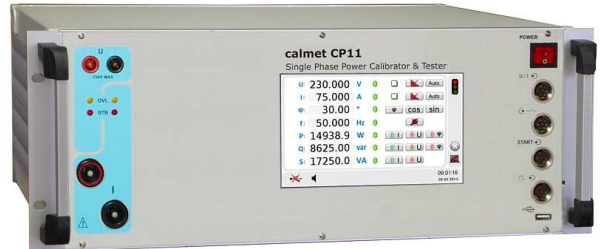

The CP11 Calibrator and Tester is used for calibration and testing a wide range of measuring instruments used in power engineering and enables testing:



AC voltmeters, AC ammeters, frequency meters, phase angle meters, power factor meters, wattmeters, VARmeters, VAmeters, clamps meters and much more,

power quality analysers, recorders and flickermeters IEC 61000-4-30 class A for EN 50160 compatibility or individual requirements of user.

The CP11 enables automatic testing with calculating of errors and standard deviation:



electricity meters EN 50470 with accuracy relative to internal reference including: measure the basic error and influence of frequency, voltage, self-heating, distortion,..., checking the starting current and no-load run,

electrical measuring transducers for converting a.c. electrical quantities EN 60688 (voltage, current, active power, reactive power, frequency, phase angle, power factor),

current instrument transformers EN 60044 including measure the accuracy of current and phase angle as well as burden measurement,

current clamps with AC & DC voltage and current output including measure the accuracy of current and phase angle,

protective relays EN 60255 including checking of tripping time and tripping level characteristics of ANSI#21 Distance relays, ANSI#27/59 Under/over voltage relays, ANSI#32 Directional power relays, ANSI#50/51 Time overcurrent relays, ANSI#81 Frequency relays and more protective relays.

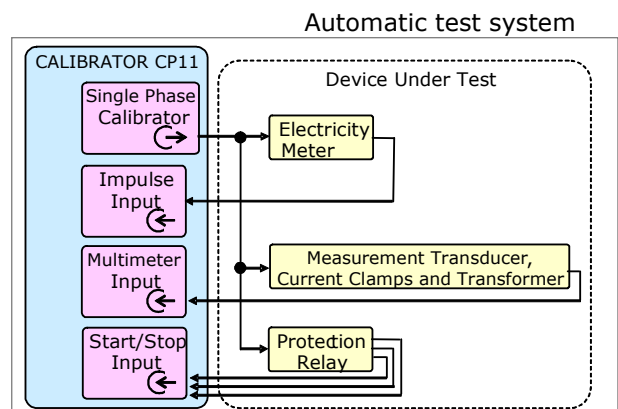

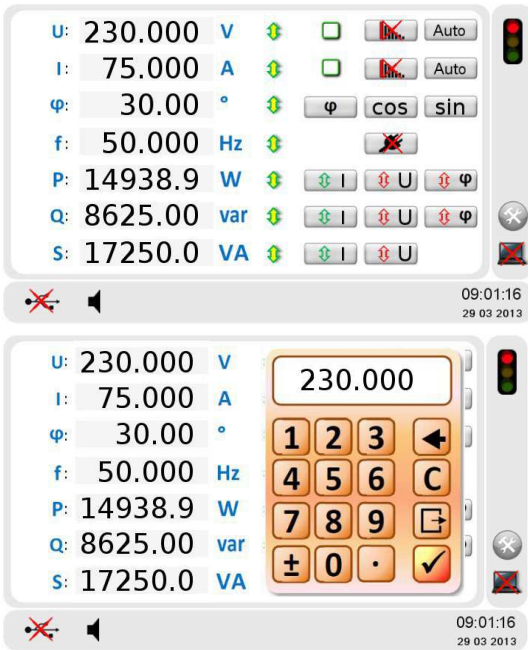

Intuitive front panel design with large Touchscreen display and ergonomic keyboard for ease of use enables:

- setting the value of voltage U, current I, phase angle φ or power factor cos/sin, frequency f and powers P, Q, S (by changing I, U or φ) with using numeric keyboard or ↑ ↓ keys to decrease or increase setting with different speed,
- selecting of voltage and current constant range and autorange mode,
- switching ON/OFF waveform distortion of voltage and current,
- switching Operate/Standby state of calibrator's output.

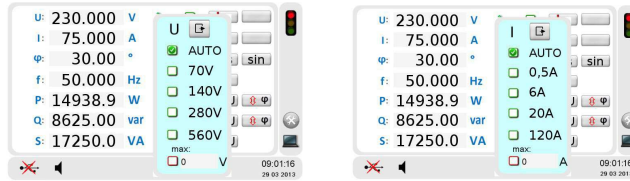

Specifications						
Parameter	Range	Setting range	Resolution	Accuracy ¹⁾		Maximum load
				class 0.02	class 0.05	
Voltage U	70V	0.5000...70.0000V	0.0001V	±0.02% ²⁾⁴⁾	±0.05% ²⁾⁴⁾	560mA@70V
	140V	1.000...140.000V	0.001V			280mA@140V
	280V	2.000...280.000V	0.001V			140mA@280V
	560V	5.000...560.000V	0.001V			70mA@560V
Current I	0.5A	0.001000...0.500000A	0.000001A	±0.02% ²⁾⁵⁾	±0.05% ²⁾⁵⁾	17V@0.5A
	6A	0.05000...6.00000A	0.00001A			8.5V@6A
	20A	0.2000...20.0000A	0.0001A			3.3V@20A
	120A	1.000...120.000A	0.001A			0.95V@60A 0.70V@120A
Frequency f		40.000...99.999Hz	0.001Hz	±0.005%		
		100.000...500.000Hz	0.001Hz			
Phase shift φ		0.00...±360.00°	0.01°	±0.05° ²⁾	±0.10° ²⁾	
Active Power P		0...3x67200.0W	0.00001-1W	±0.02% ²⁾³⁾	±0.05% ²⁾³⁾	
Reactive Power Q		0...3x67200.0var	0.00001-1var	±0.02% ²⁾³⁾	±0.05% ²⁾³⁾	
Apparent Power S		0...3x67200.0VA	0.00001-1VA	±0.02% ²⁾	±0.05% ²⁾	
Time ⁶⁾		1...36000s	1s	±0.01% ±0.001s		
Energy		calculated from settings of power and time		±0.02% ²⁾³⁾	±0.05% ²⁾³⁾	

¹⁾ absolute extended uncertainty under confidence level of 95% including stability in 12 months in frequency range 45-65Hz
²⁾ of setting value from 10% of current range and 30% of voltage range
³⁾ uncertainty of power P(Q) under cosφ(sinφ)=1
⁴⁾ for voltage below 30% of range uncertainty 0.006% of range (class 0.02) or 0.015% of range (class 0.05)
⁵⁾ for current below 10% of range uncertainty 0.002% of range (class 0.02) or 0.005% of range (class 0.05)
⁶⁾ for energy dosage

General parameters	
Weight and dimensions (width x height x depth)	14kg and (478x194x360)mm
Power supply	90V...264V / 47...63Hz / 300VA

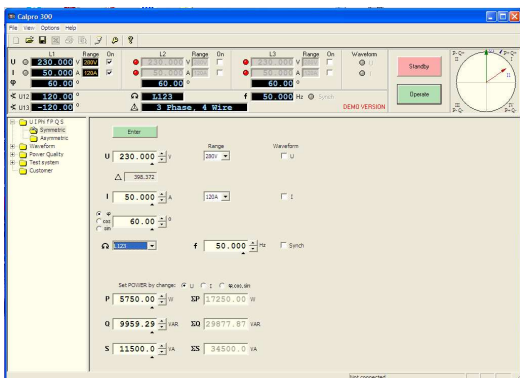

Calpro 300 Basic PC software version enables traditional manual setting the value of all parameters of output signals and setting the wave shape of voltage and current.

Calpro 300 PQ Power Quality PC software version enables generating sinusoidal and nonsinusoidal voltage and current, which value is changed in time.

Calpro 300 TS Test System PC software version enables using a modern concept, which allows the operator to create own test procedures with using automated / manual mode and computer database of customers, devices, measurement procedures, results, diagrams and tables with reports edition.

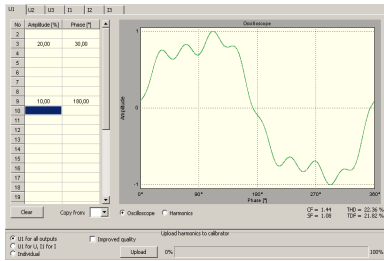

Power Quality function enables generation of nonsinusoidal voltage and current waveforms with harmonics, interharmonics and subharmonics as well as simulation of voltage, current, phase shift and frequency variations as a function of time (dips, interruptions, swells, flicker, fluctuations and ramp signals).

PQ functions meet all accuracy requirements of power quality testing to the EN 61000-4 series of standards.

Harmonics

Harmonics are voltages and currents with a frequency, that is an integral multiple of the fundamental frequency. Harmonic testing is defined in EN 61000-4-7 and EN 61000-4-13.

The CP11 can generate multi-harmonic distortion with independent superposition of harmonic components of current and voltage, with levels 0...100% and phase angle 0...360° of the first harmonic.

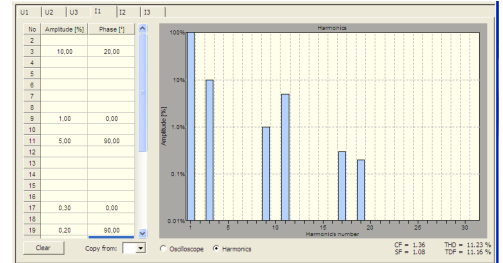

Interharmonics

Interharmonics are voltages with a frequency, that is a non-integral multiple of the fundamental frequency. For example, in 50Hz supply system, 150Hz is a harmonic (the third) but 175Hz is an interharmonic. Interharmonic testing is defined in EN 61000-4-7 and EN 61000-4-13.

The CP11 can generate interharmonics at a user-definable frequency up to 3200Hz, amplitude and phase angle.

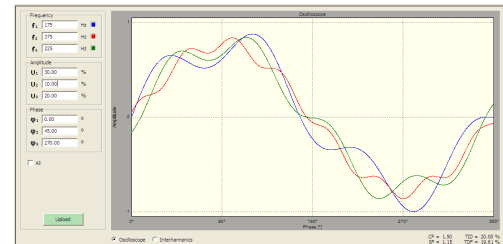

Dips, Interruptions, Swells and Shocs

Dips are a temporary reduction of the voltage below nominal (Interruptions below 1% nominal) and Swells are a temporary increase of the voltage above nominal up to 200% nominal for a time from 10ms up to several minutes. Shocs (Inrush current) are a temporary increase of the current above nominal when first turned on of an electrical device. Dips, Interruptions and Swells testing are defined in EN 61000-4-11 and EN 61000-4-34.

The CP11 can generate a user-definable fast and slow changes of voltage and current independently.

CP11 output signals recorded by digital oscilloscope

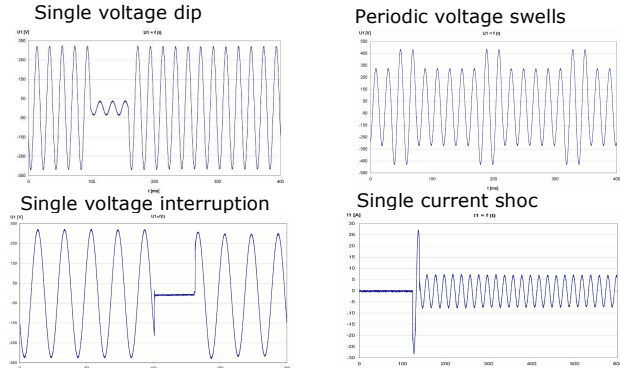

Flicker

Flicker is a specific measurement, which sets out to measure the human sensitivity of a flickering light caused by supply voltage fluctuation around of a nominal value. Flickermeter testing is defined in EN 61000-4-15.

The CP11 generates voltage changes for performance testing and displays the results in P_{st} / P_{it} severity including combined frequency/voltage changes, harmonic/interharmonic distortion and phase jumps.

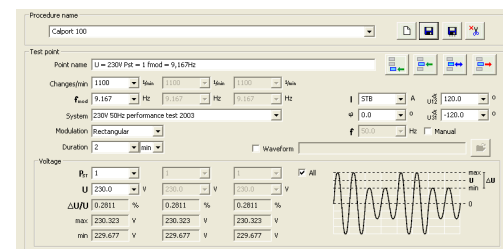

Specifications					
Parameter	Setting range	Resolution	Accuracy ¹⁾		Conditions
			class 0.02	class 0.05	
Harmonics	amplitude	0...100% of output	0.01%	±0.02% ²⁾	up to 31 st or 3200Hz
	phase	0...360°	0.01°	±0.5° ²⁾	
Interharmonics in voltage	0...30% of output	0.01%	±0.2% ³⁾		for 16...9000Hz
Dip	amplitude	0...100% of nominal	6 digits	±0.05% ⁴⁾	
	duration	0.02...999s	0.001s	0.001s	
Swell	amplitude	0...200% of nominal	6 digits	±0.05% ⁴⁾	
	duration	0.02...999s	0.001s	0.001s	
Flicker	P _{st}	0...40	0.00001	±1% acc. to IEC61000-4-15	
	modulation	0.1...4000CPM or 0.000833...33.33Hz	7 digits or 4 digits		
	duration	1s...999h	1s		

¹⁾ absolute extended uncertainty under confidence level of 95% including stability in 12 months in frequency range 45-65Hz
²⁾ 0.02% of output and 0.5° for 80-120Hz frequency range of harmonics with linear rise to 0.2% of output and 4° for 3200Hz
³⁾ 0.05% of output for 16-120Hz frequency range of interharmonics with linear rise to 2% of output for 9000Hz
⁴⁾ with voltage and current accuracy for 0.05 class calibrator in voltage and current setting range

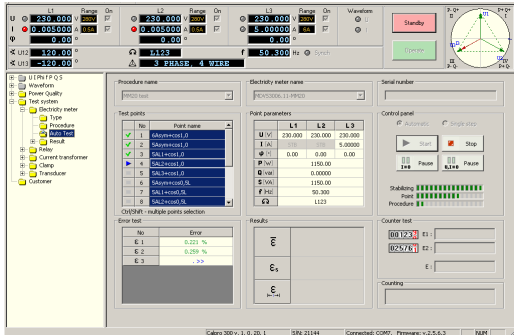

Test System function for testing of electricity meters, measurement of industrial transducers, current clamps, current transformers and protection relays in fully automatic way under sinusoidal and nonsinusoidal conditions, for example the CP11 can be used to type test from 0.1% to 2% energy meters acc. to EN 50470.

Current output provides currents in full current range from 1mA up to 120A through compact banana sockets without needed to manual switch current terminals during test.

Specifications of calibrator's inputs / outputs for automatic tests					
Input / output		Range	Accuracy ¹⁾	Number of inputs/outputs	Conditions
Impulse Input for counting pulses from electricity meter, photo scanning head or reference meter		range of input voltage 0...2V/4...30V		1	frequency of impulses up to 100Hz
Multimeter Input	DC Voltage	0...10.0000V	0.02% of range	1	
	DC Current	0...20.000mA	0.02% of range		
	AC Voltage	0...10.000V	0.1% of range		
	AC Current	0...100.00mA 0...5.000A	0.1% of range 0.1% of range		
Start/Stop Input for time measurement		0.001...100.000s	0.001s	3	range of input voltage 15...250V DC/AC
Binary Output of operate/standby for signalling state of Calibrator			time of state change 0.001s	2	output load 250VDC/0.5A/10VA
Impulse Output for CP11 testing		0.0001Hz...210kHz		1	open collector U _s ≤28V and I _c ≤100mA
¹⁾ absolute extended uncertainty under confidence level of 95% including stability in 12 months, for AC inputs in frequency range 45-65Hz					

CP11 Calibrator's equipment	
<p>All completed CP11 Calibrator's set consists of:</p> <ul style="list-style-type: none"> CP11 calibrator case class 0.02 or 0.05, power cord, Calpro 300 Soft – Basic Version, USB mini / USB A interface cable, fuse T2A, 250V, 5x20 (2units), set of safety voltage cables (2units), set of safety current cables up to 20A (2units), set of accessories for safety cables (4units banana plug +4units Cu), AD300 sockets adapter, C091A T3475-001 plug Amphenol for Calibrator inputs, operation manual of calibrator and software (2units), warranty card, calibration certificate. 	<p>Optionally for CP11 Calibrator are available:</p> <ul style="list-style-type: none"> computer Laptop, Calpro 300TS PC Soft for automatic test of electric equipment, Calpro 300PQ PC Soft for Power Quality measurement devices testing, C300LabView-LabView Driver for CP11 Calibrator, EA11 current cables up to 120A (2units) with set (6units) of replaceable terminals, ET11 transportation case for portable work, CF102 photo head with holder for inductive meter and meter with LED, MPX8 Eight Inputs Multiplexer, ZW100/10A coil 100 turns / 10A, ZW10/20A coil 10 turns / 20A.



Calmet Ltd
 Kukulcza 18, 65-472 Zielona Gora, Poland
 Phone +48 68 324 04 56 Fax +48 68 324 04 57
 E-mail: mail@calmet.com.pl Web access: http://www.calmet.com.pl