

Three Phase Network Analyser and Tester of Electricity Meters and Instrument Transformers

Calmet TE30

- Measure of power network parameters in class 0.05 or 0.1
- Voltage ranges 0.05...600V and 0.1...40kV
- Current ranges 0.001...12(120)(1200)(30/300/3000)A
- Testing of electricity meters and CT/PT Transformers
- Recording and analyse of power quality
- Vector, oscilloscope, bar and trend charts of three phase network
- Powering from 50...450V AC power network and internal battery with charger
- Large 7" color Touchscreen and Calmet TE30 PC soft
- Data readout and meter control via USB, Ethernet and Bluetooth
- Data storage in SD flash memory card up to 32GB
- Calibration Certificate



The Calmet TE30 Analyser and Tester is used for:



- verification of power network wiring with measure and recording of power network parameters,
- calibration and testing of electricity meters and instrument transformers (CT Current Transformers and PT Potential Transformers) directly on site:
 - electricity meters** EN 50470, IEC 62052 and IEC 62053 with accuracy relative to internal reference including measure of meter error, counter error and maximum power meter error,
 - instrument transformers** EN 60044 including CT/PT Ratio error and phase error as well as CT/PT burden simultaneously in three phases,
- measuring, recording and analyzing of power quality.

Examples of applications

Electricity meter testing – direct connection

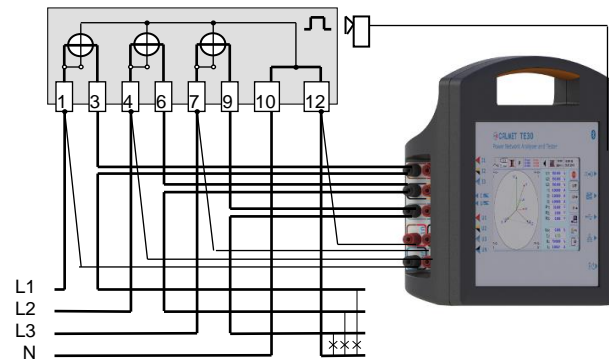

Electricity meter testing – connection with clamps

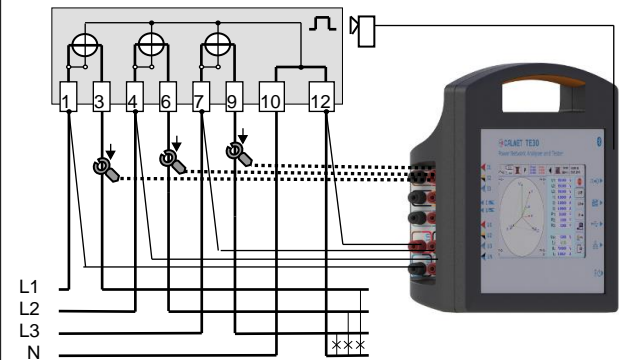

CT Ratio error and phase error testing

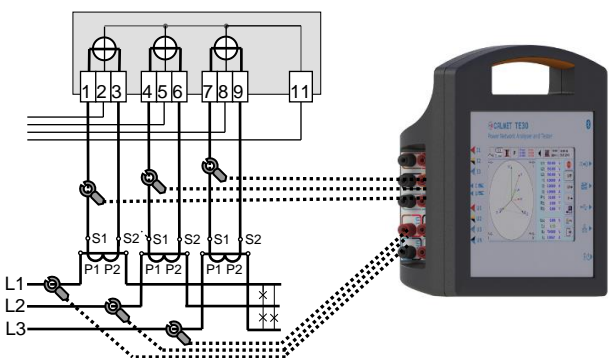

Electricity meter testing – connection with clamps

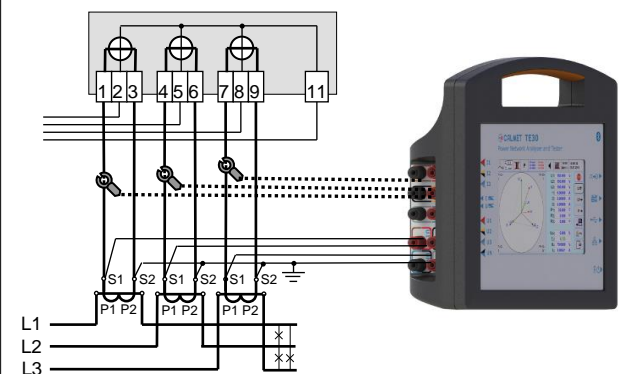

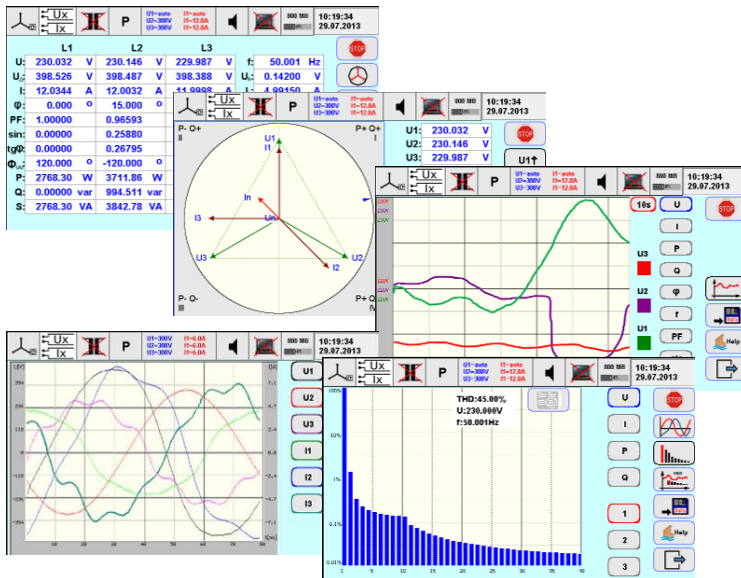

Large Touchscreen with display and keyboard functions for easy operation enables:

- measure of power network parameters: voltages U1, U2, U3, U12, U23, U31, UN, currents I1, I2, I3, IN, frequency f, phase angles $\varphi_1, \varphi_2, \varphi_3$, power factors PF1, PF2, PF3, Σ PF, factors $\sin\varphi_1, \sin\varphi_2, \sin\varphi_3, \Sigma\sin\varphi, \text{tg}\varphi_1, \text{tg}\varphi_2, \text{tg}\varphi_3, \Sigma\text{tg}\varphi$, angles between voltages $\angle U_{12}, \angle U_{23}, \angle U_{31}$, powers P1, P2, P3, Σ P, Q1, Q2, Q3, Σ Q, S1, S2, S3, Σ S,
- visualization of measurement results in form of: table, vectors, trend chart, oscilloscope (waveform) or bar chart (harmonics of U, I, P, Q).

Specifications for a power network analyser			
Parameter	Range	Error limits 1)2)3)4)	
		class 0.05	class 0.1
Voltage (Direct)	0.05...600V	$\pm 0.05\%$ 5)	$\pm 0.1\%$ 5)
Voltage (VoltLiteWire 40kV)	0.1...40kV	$\pm 0.1\% \pm \text{Em}$	
Current (Direct)	0.01...12A	$\pm 0.05\%$	$\pm 0.1\%$
	0.001...0.01A	$\pm 0.05\%*$	$\pm 0.1\%*$
Current (Clamps CT10AC)	0.1...12A	$\pm 0.2\%$	
	0.003...0.1A	$\pm 0.2\%*$	
Current (Clamps CT100AC)	0.1...120A	$\pm 0.2\%$	
	0.01...0.1A	$\pm 0.2\%*$	
Current (Clamps CT1000AC)	10...1200A	$\pm 0.2\%$	
	0.3...10A	$\pm 0.2\%*$	
Current (Flexible Clamps FCT3000AC)	0.3...30A/3...300A/30...3000A	$\pm 0.1\% \pm \text{Em}$	
Current (AmpLiteWire 2000A)	30...2000A	$\pm 0.1\% \pm \text{Em}$	
Power and energy (Direct)	0.01...12A / 10...600V	$\pm 0.05\%$	$\pm 0.1\%$
	0.001...0.01A / 10...600V	$\pm 0.05\%*$	$\pm 0.1\%*$
Power and energy (Clamps CT10AC)	0.1...12A / 10...600V	$\pm 0.2\%$	
	0.01...0.1A / 10...600V	$\pm 0.2\%*$	
Power and energy (Clamps CT100AC)	0.1...120A / 10...600V	$\pm 0.2\%$	
	0.01...0.1A / 10...600V	$\pm 0.2\%*$	
Power and energy (Clamps CT1000AC)	10...1200A / 10...600V	$\pm 0.2\%$	
	1...10A / 10...600V	$\pm 0.2\%*$	
Power and energy (Flexible Clamps FCT3000AC)	0.3...30A/3...300A/30...3000A / 10...600V	$\pm 0.1\% \pm \text{Em}$	
Power and energy (VoltLiteWire 40kV + AmpLiteWire 2000A)	30...2000A / 0.5...40kV	$\pm 0.1\% \pm \text{Em}$	
Frequency	40...70Hz	$\pm 0.01\text{Hz}$	
Phase shift (Direct)	-180...+180°	$\pm 0.02^\circ$ 5)6)	$\pm 0.04^\circ$ 5)6)
Phase shift (Clamps)	-180...+180°	$\pm 0.1^\circ$ 5)7)	
Power factor $\cos\varphi$ and $\sin\varphi$	0...±1	± 0.001 5)6)7)	
Temperature coefficient (Direct)	0.005% per 1°C in range -10...+50°C		
Time stability (Direct)	Short term [1h] = 0.01%, long term [1 year] = 0.03%		

1) % - related to the measuring value, %* - related to the measuring range final value (is underlined)
 2) error limits include reference uncertainty of standards, stability in 12 months, influence quantities (ambient temperature in range +20...+26°C, humidity and power supply voltage in range 50...450V, frequency in range 45...65Hz)
 3) Em - sensor basic error, $\text{Em}=1\%+0.1\%*$ (Flexible Clamps FCT3000AC), $\text{Em}=2\%+0.2\%*$ (VoltLiteWire 40kV and AmpLiteWire 2000A)
 4) power and energy errors related to apparent power
 5) in voltage range 10...600V (Direct)
 6) in current range 0.01...12A (Direct)
 7) in current range: 0.1A...12A (Clamps CT10AC), 0.1A...120A (Clamps CT100AC), 10A...1200A (Clamps CT1000AC)

General parameters	
Weight and dimensions (width x height x depth)	2kg (with internal battery) and (270x245x90)mm
Power supply	50...450V / 47...63Hz / 15VA or replaceable batteries Ni-MH 5xAA 1.2V / 2600mAh / 2h
Safety: Isolation protection and Measurement Category	IEC 61010-1 and 300V CAT III
Degree of protection	Device is placed in IP67 housing
Operation / storage temperature	-10...+50°C / -20...+60°C
Operation / storage relative humidity	<90% @ +0...+30°C and <75% @ +30...+50°C / <95% @ 0...+50°C

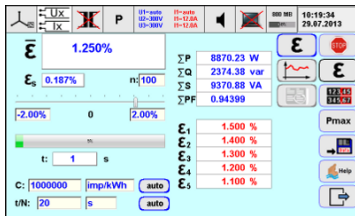

Testing of electricity meters directly on site:

- function of calculating meter error (partial errors, average error, standard deviation) directly in [%] with method of settings time of measurements or number of impulses,
- function of automatic identification meter constant,
- function of automatic determining measurement time or number of pulses,

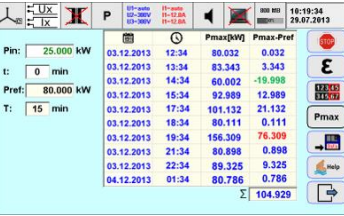
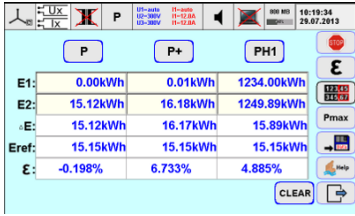

- function of measuring energy with method of setting time for verification of meter counters directly in [%],
- function of maximum power measuring for testing of maximum power meters,
- visualization in form of table or trend chart,

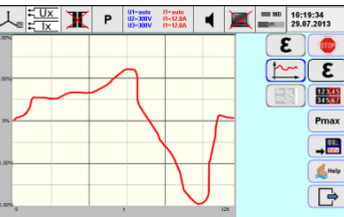
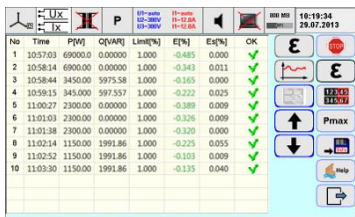

- function of measuring energy for power P, P+, P-, Q, Q+, Q-, S,
- function of measuring energy for the first harmonic of active power PH1.

Specifications for automatic tests of electricity meters			
Parameter	Voltage and current range	Frequency range	Resolution
Impulse Input for counting pulses from electricity meter, photo scanning head or reference meter	0...2V/4...30V	0.00001Hz...200kHz	0.0001%@t≥1s
Impulse Output for Calmet TE30 testing ¹⁾	28V/100mA open collector	0.0001Hz...210kHz	

¹⁾ Programmable constant of Impulse Output – preferred value: C = 30 000 [imp/Wh(varh,Vah)]

Testing of instrument transformers (LV and MV current CT and potential PT simultaneously in three phases) directly on site:

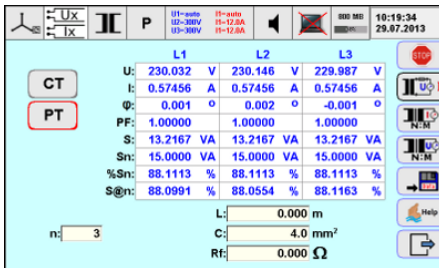

- functions of calculating transformer ratio error directly in [%],
- functions of calculating phase error,
- functions of burden measurements of transformer

Specifications for Burden measurement tests of CT and PT transformers			
Parameter	Current range	Voltage range	Error limits ¹⁾²⁾
CT Burden	0.01...12A (Direct)	1...10V (Direct) 0.05...1V (Direct)	±0.2% ±0.2%*
PT Burden	0.01...12A (Direct) 0.001...0.01A (Direct)	10...600V (Direct) 10...600V (Direct)	±0.1% ±0.1%*

Specifications for Ratio measurement tests of CT and PT transformers			
Parameter	Primary current/voltage range	Secondary current/voltage range	Error limits ¹⁾²⁾³⁾
CT Ratio	0.2...120A (Clamps CT100AC)	0.01...12A (Direct) 0.001...0.01A (Direct)	±0.2% ±0.2%*
CT Ratio	10...1200A (Clamps CT1000AC)	0.01...12A (Direct)	±0.2%
CT Ratio	0.3...30A/3...300A/30...3000A (Flexible Clamps FCT3000AC)	0.01...12A (Direct)	±0.1%±Em
CT Ratio	30...2000A (AmpLiteWire 2000A)	0.01...12A (Direct)	±0.1%±Em
PT Ratio	0.5...40kV (VoltLiteWire 40kV)	10...600V (Direct)	±0.1%±Em

¹⁾ % - related to the measuring value, %* - related to the measuring range final value (is underlined)
²⁾ error limits of operating Burden or Ratio - covers reference uncertainty of standards, stability in 12 months, influence quantities (ambient temperature in range +20...+26°C, humidity and power supply voltage in range 50-450V, frequency in range 45...65Hz)
³⁾ Em - sensor basic error, Em=1%+0.1%* (Flexible Clamps FCT3000AC), Em=2%+0.2%* (AmpLiteWire 2000A and VoltLiteWire 40kV)

Power quality analyser function enables:

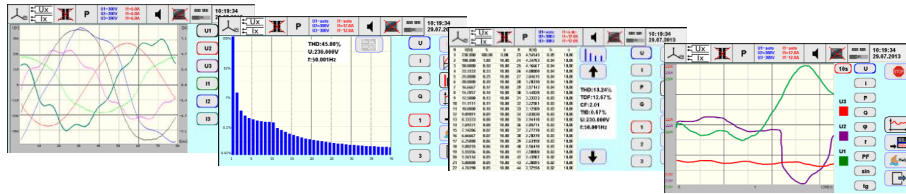

- measuring of power quality parameters according to IEC 61000-4-30 class A with visualization of measurement results in the real time mode,

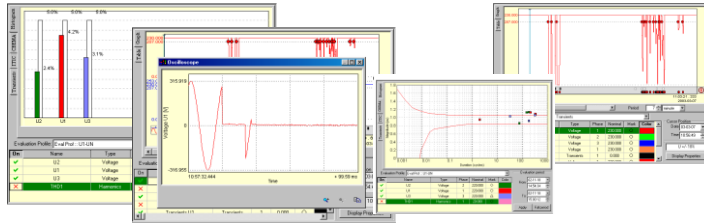

- recording of power network parameters in the SD Flash 4-32GB memory, which gives $(8\div64)\times 10^6$ sets of network parameters or long-term registration of power quality (option),
- analyzing of measurement results for EN 50160 compatibility or individual requirements of user (option).

Specifications for a power quality parameters			
Parameter		Range	Error limits ¹⁾
Harmonics in voltages, currents, P and Q powers	amplitude	0...100% of input	1 st ...63 rd
	phase	-180...+180°	
Total harmonic distortion THD in voltages and currents		0...100% of input	±0.1% ²⁾
Total interharmonic distortion TID in voltages and currents		0...15% of input	±0.5% ³⁾
Signal voltage ⁵⁾		40...3200Hz	±0.1% ²⁾
Flicker P _{st} and P _{lt} (option)		0...15% of input	±0.2% ⁴⁾
Voltage asymmetry		0...40	±5%
		0...100%	±2%

¹⁾ error limits covers reference uncertainty of standards, stability in 12 months, influence quantities (ambient temperature in range +20...+26°C, humidity and power supply voltage in range 50-450V, frequency in range 45...65Hz
²⁾ of input for 80-140Hz frequency range of harmonics with linear rise to 0.4% of input for 3200Hz
³⁾ for 80-140Hz frequency range of harmonics with linear rise to 8° for 3200Hz
⁴⁾ of input for 80-140Hz frequency range of interharmonics with linear rise to 5% of input for 3200Hz
⁵⁾ the highest non-harmonic amplitude and frequency

Calmet TE30 Analyser's equipment			
All completed Calmet TE30 Analyser's set consists of:			
<ul style="list-style-type: none"> Calmet TE30 analyser class 0.05 or 0.1, power cord, fuse T500mA 250V (2pcs), memory card SD 8GB, operation manual, warranty card, calibration certificate. 			
Optionally for Calmet TE30 Analyser are available:			
<ul style="list-style-type: none"> Calmet TE30 PC Soft with operation manual and USB mini / USB A interface cable, 		<ul style="list-style-type: none"> CT10AC electronic compensated clamps up to 12A (1compl), 	
<ul style="list-style-type: none"> AD100EXT extension for powering from measurement network, 		<ul style="list-style-type: none"> CT100AC electronic compensated clamps up to 120A (1compl), 	
<ul style="list-style-type: none"> EA30 set of safety measurement cables (10pcs), 		<ul style="list-style-type: none"> CT1000AC electronic compensated clamps up to 1200A (1compl), 	
<ul style="list-style-type: none"> AKD100 additional accessories (handlers and terminals 42pcs) of safety cables, 		<ul style="list-style-type: none"> FCT3000AC electronic compensated flexible clamps in ranges 30/300/3000A (1compl), 	
<ul style="list-style-type: none"> CF106H photo head with holder for inductive meter and meter with LED, 		<ul style="list-style-type: none"> AmpLiteWire 2000A primary current sensors up to 2000A for LV and MV nets (1pc), 	
<ul style="list-style-type: none"> DR200C miniature thermal printer with Bluetooth, 		<ul style="list-style-type: none"> VoltLiteWire 40kV primary sensors up to 40kV (1pc), 	
<ul style="list-style-type: none"> ET30 transportation case, 		<ul style="list-style-type: none"> rechargeable battery NiMH AA R6 1.2V 2700mAh (5pcs), 	
<ul style="list-style-type: none"> ET32 transportation case for additional accessories, 		<ul style="list-style-type: none"> Calmet TE30 option set 01 (Calmet TE30+ET30+CT100AC+CF106H+EA30+AKD100). 	
<ul style="list-style-type: none"> FCT1000AC electronic compensated flexible clamps up to 1000A (1compl), 			

Calmet sp. z o.o.
 Kukulcza 18, 65-472 Zielona Gora, Poland
 Phone +48 68 324 04 56 Fax +48 68 324 04 57
 E-mail: mail@calmet.com.pl Web access: http://www.calmet.com.pl